

Data Sheet

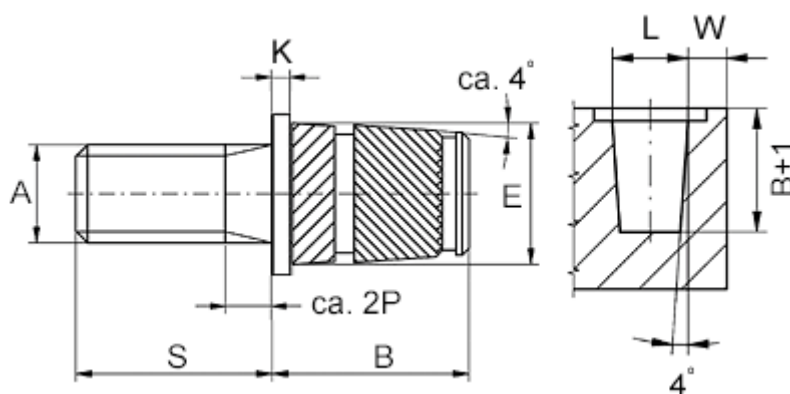

Article number: 12859100060840
Description: KLEE-coil 859 100 060.840
M6 Brass

Measures



Flange diameter E1	= 10.0
Flange height	= 1.3
Male thread A	= M6x1
Min distance to edge W	= 2.5
Mounting length B	= 11.3
Outer diameter E	= 8.8
Pin length S	= 10
Recommended bore diameter W +0.1	= 8.5